

690 Series

Multiple Stainless Steel Case Styles

COMMERCIAL • CONTRACTOR GAUGES



690B shown



- ▶ 3 1/2" Dial Size
- ▶ ±1.0% Accuracy
- ▶ Polished Stainless Steel Case
- ▶ Multiple Case Styles

Trerice **690 Series** Commercial Gauges are offered in a polished stainless steel case to provide the durability and styling required in OEM and other applications. This gauge is available in a variety of case styles. Wetted parts are a bronze tube with brass socket.

- Optional features available: Please consult the Options & Accessories Section for details.
- For correct use and application of all pressure gauges, please refer to: Pressure Gauge Standard ASME B40.100.

HOW TO ORDER







Sample Order Number: **690B 35 02 L D 110**

Model	Dial Size	Connection Size	Connection Location	Units of Measure	Range Code
690B 691B 692B 693B 694B 696B	35 3 1/2"	02 1/4 NPT	L Lower * B Back **	D psi/kPa A psi B kPa	See Standard Ranges

* For Models 690B & 692B only

** For Models 691B, 693B, 694B & 696B only

Specifications

Models	Case Styles
690B	 Flangeless, stem mounted with bottom outlet
691B	 Flangeless, stem mounted with back outlet
692B	 Surface Mounted, back flanged with bottom outlet
693B	 Flush Mounted, front flanged with bottom outlet
694B	 Flush Mounted, u-clamp with back outlet
696B	 Surface Mounted, back flanged with back outlet

Dial Size 3 1/2"

Wetted Parts Bronze tube, brass socket

Movement Brass

Connection **690B, 692B:** Lower male, 1/4 NPT
691B, 693B, 694B, 696B: Center back male, 1/4 NPT

Window Acrylic, snap-in

Pointer Adjustable, black finish

Dial Face Aluminum, white background with black graduations and markings

Accuracy ±1.0% Full Scale, ASME B40.100 Grade 1A

Maximum Temperature 150°F (65°C)

Approximate Shipping Weight
690B, 691B, 692B, 696B: 0.6 lbs [0.27 kg]
693B: 0.8 lbs [0.36 kg]
694B: 0.9 lbs [0.41 kg]

690 Series

Multiple Stainless Steel Case Styles

All dimensions are nominal. Dimensions in [] are in millimeters.

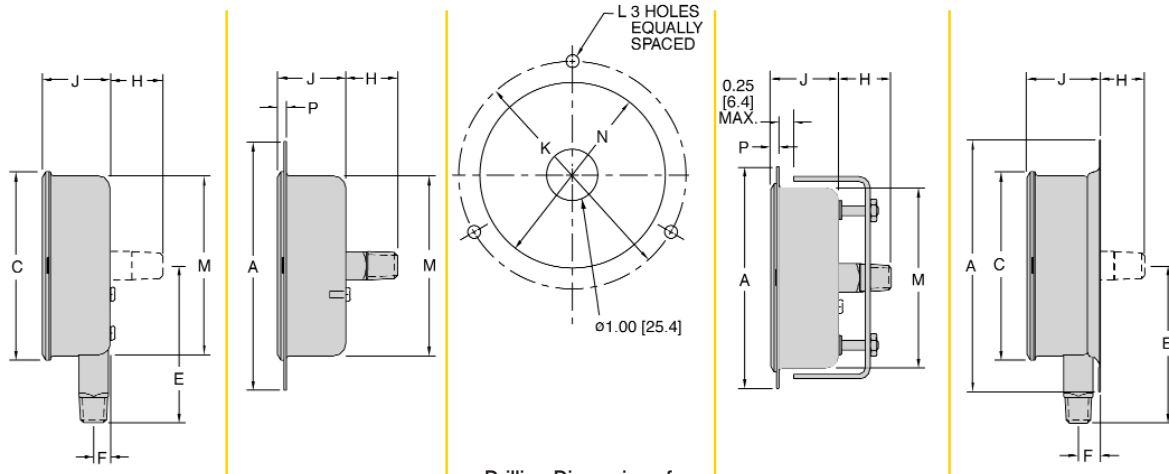

690B / 691B

693B

692B / 693B / 696B

694B

692B / 696B

Model	A	C	E	F	H	J	K	L	M	N	P
690B	N/A	3.67 [93.2]	3.06 [77.8]	0.32 [8.2]	N/A	1.33 [33.8]	N/A	N/A	3.51 [89.2]	N/A	0.17 [4.3]
691B	N/A	3.67 [93.2]	N/A	N/A	1.01 [25.8]	1.33 [33.8]	N/A	N/A	3.51 [89.2]	N/A	0.17 [4.3]
692B	4.91 [124.7]	3.67 [93.2]	3.06 [77.8]	0.43 [11]	0.90 [23.0]	1.44 [36.6]	4.50 [114.3]	0.25 [6.4]	N/A	N/A	N/A
693B	4.84 [122.9]	N/A	N/A	N/A	1.01 [25.8]	1.33 [33.8]	4.44 [112.8]	0.25 [6.4]	3.51 [89.2]	3.62 [92]	0.17 [4.3]
694B	4.31 [109.5]	N/A	N/A	N/A	1.01 [25.8]	1.33 [33.8]	N/A	N/A	3.51 [89.2]	3.62 [92]	0.17 [4.3]
696B	4.91 [124.7]	3.67 [93.2]	N/A	N/A	0.90 [23]	1.44 [36.6]	4.50 [114.3]	0.25 [6.4]	N/A	N/A	N/A

Standard Ranges

Range Code	psi/kPa Ranges (D)		psi (A)		kPa (B)	
	Specific Range (psi)		Figure Intervals	Minor Divisions	Figure Intervals	Minor Divisions
010	30" Hg to 0 / -100 to 0 kPa		5	0.2	10	1
020	30" Hg to 15 psi / -100 to 100 kPa		5/5	0.5/0.2	20	2
030	30" Hg to 30 psi / -100 to 200 kPa		10/5	1/0.5	50	2
040	30" Hg to 60 psi / -100 to 400 kPa		10/10	1/1	50	5
050	30" Hg to 100 psi / -100 to 700 kPa		30/10	2/1	100	5
060	30" Hg to 150 psi / -100 to 1000 kPa		30/20	5/2	100	10
070	30" Hg to 300 psi / -100 to 2000 kPa		30/50	5/2	100	20
080	0 to 15 psi / 0 to 100 kPa		3	0.1	10	1
090	0 to 30 psi / 0 to 200 kPa		5	0.2	20	2
100	0 to 60 psi / 0 to 400 kPa		10	0.5	50	5
110	0 to 100 psi / 0 to 700 kPa		10	1	100	5
120	0 to 160 psi / 0 to 1100 kPa		20	1	100	10
130	0 to 200 psi / 0 to 1400 kPa		20	2	200	10
140	0 to 300 psi / 0 to 2000 kPa		50	2	200	20
150	0 to 400 psi / 0 to 2800 kPa		50	5	400	20
160	0 to 600 psi / 0 to 4000 kPa		50	5	500	50
180	0 to 1000 psi / 0 to 7000 kPa		100	10	1000	50

Other pressure ranges are also available including: Altitude, Refrigerant and Receiver. Consult Special Application Ranges section or factory for availability.

COMMERCIAL • CONTRACTOR GAUGES